



ГИДРАВЛИЧЕСКАЯ ХАРАКТЕРИСТИКА

18.12.24

Страница 2 / 3

DAB PUMPS S.p.A.
Via Marco Polo, 14 - 35035 Mestrino (PD), Italy
Tel. +39 049 5125000 - Fax +39 049 5125950
www.dabpumps.com

Получатель

Отправитель

Company
Reference
Address
Phone
Fax
E-mail

CM 40-870 T IE3

Curve tolerance according to ISO 9906

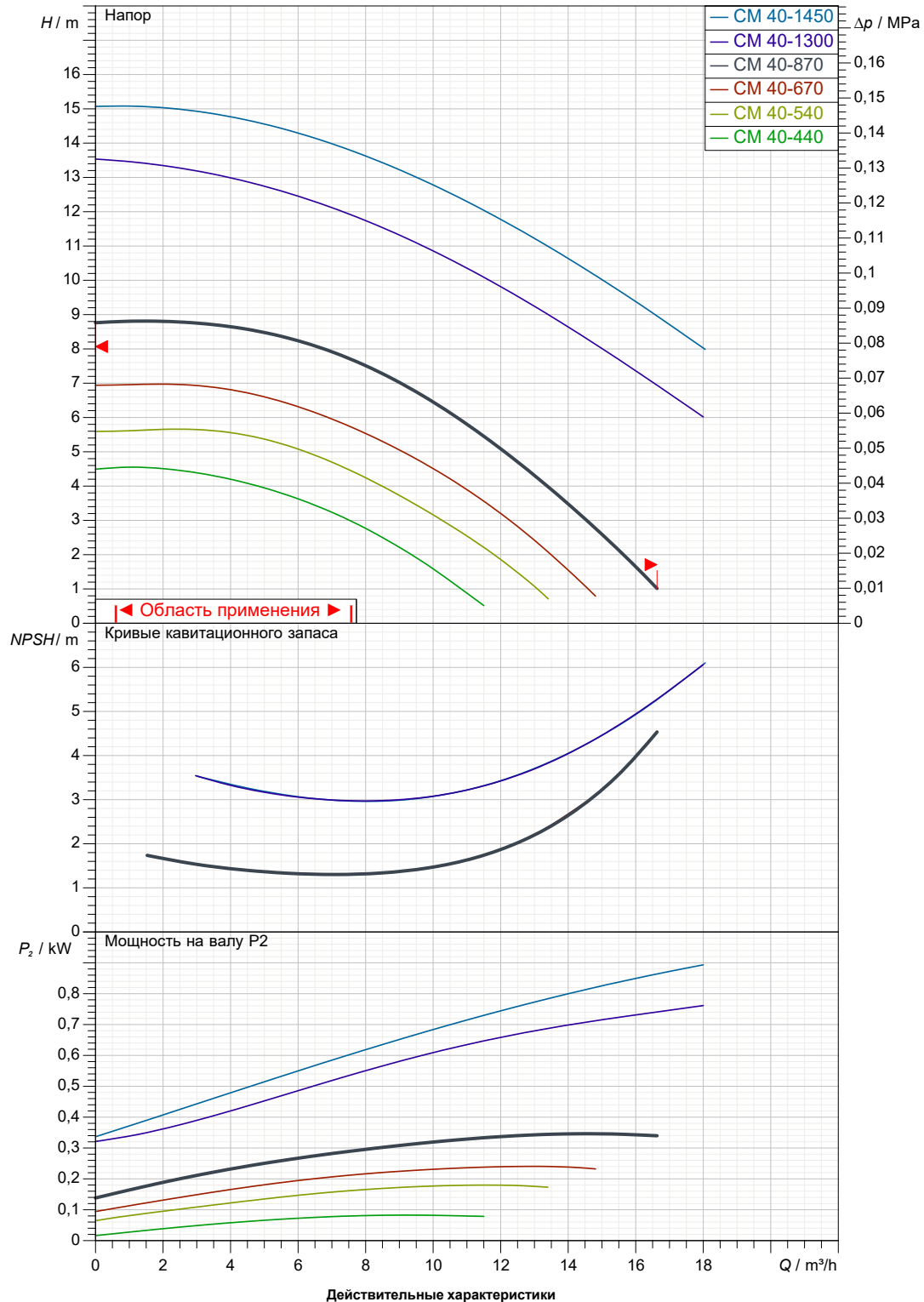

Вход
DN 40
PN 16

Вых
DN 40
PN 16

Расход :

Напор :

Частота вращения
1.480 1/min

MAIN_PROJECT_TITLE

BUSINESS_PROCESS_IC

OWNER_

ISSUE_DATE

13/12/24



ГАБАРИТНЫЕ РАЗМЕРЫ

18.12.24

Страница 3 / 3

DAB PUMPS S.p.A.
Via Marco Polo, 14 - 35035 Mestrino (PD), Italy
Tel. +39 049 5125000 - Fax +39 049 5125950
www.dabpumps.com

Получатель

Отправитель

Company
Reference
Address
Phone
Fax
E-mail

CM 40-870 T IE3

□ 32 x... ÷ 100 x...

Controflange a richiesta
Counterflanges on request

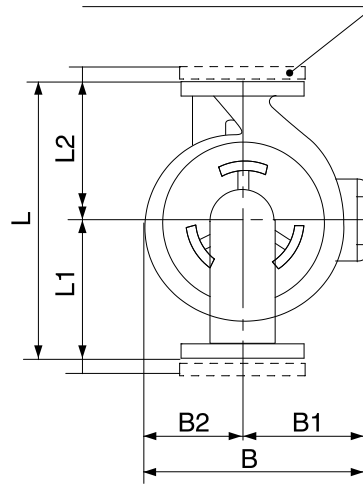
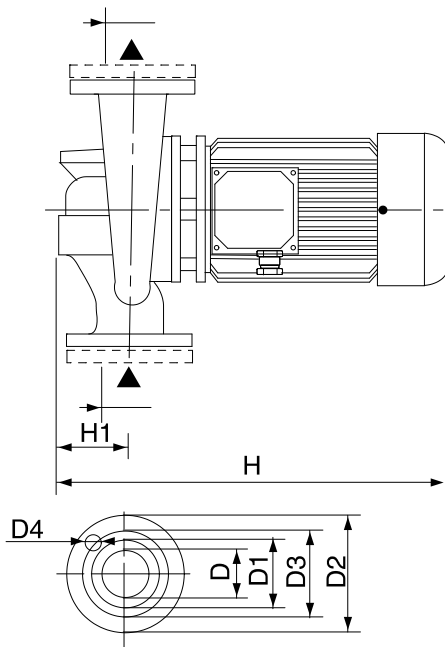

DN : Flange / Flanges

DT : Ø Tubazione / Ø Piping

Измерения в mm

Соединения насоса:

1	B	231	L1	200	всасывании : DN 40 PN 16 подачу : DN 40 PN 16
2	B1	118	L2	190	
3	B2	113			
4	D	40 PN 16			
5	D1	88			
6	D2	150			
7	D3	110			
8	D4	4 x Ø18			
9	H	453			
10	H1	95			
11	L	390			

MAIN_PROJECT_TITLE

BUSINESS_PROCESS_I

OWNER_

ISSUE_DATE

13/12/24